

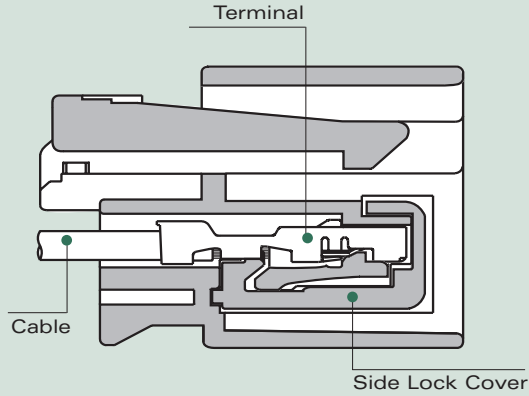

**Cross Sectional View**

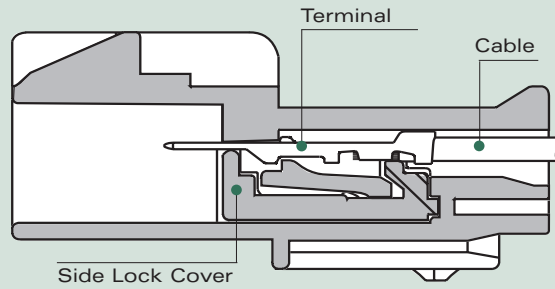

**Female Connector Assembly**



**Male Connector Assembly**

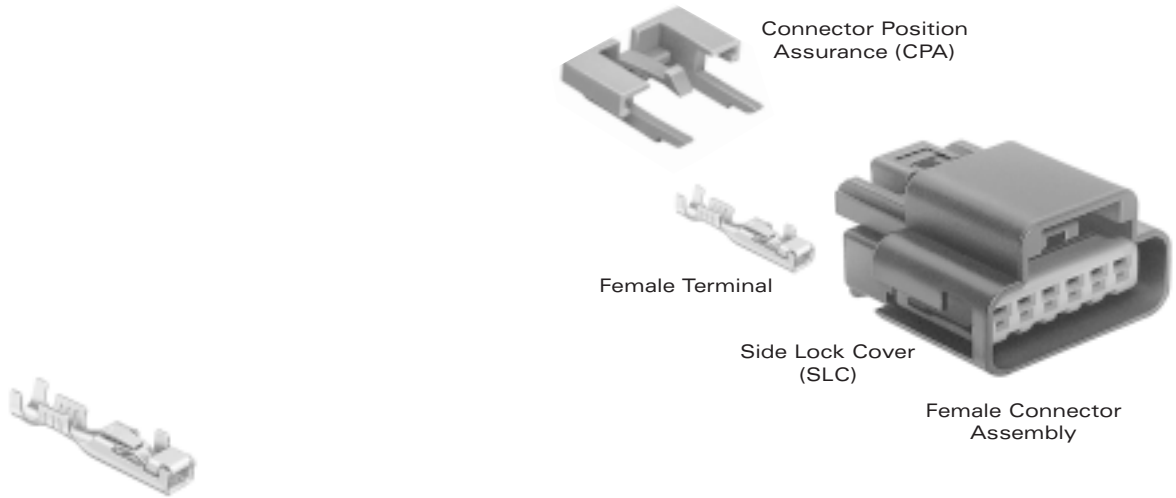

**GT 280 FEMALE TERMINALS UNSEALED**

Part #	Cable Range (mm <sup>2</sup> )	Material	Plating
15304710	0.50-0.35	Tin Brass	Tin
15304711	1.00-0.75	Tin Brass	Tin
15304712	3.00-1.50	Tin Brass	Tin
15304713	5.00-4.00	Tin Brass	Tin

**GT 280 FEMALE CONNECTOR ASSEMBLIES UNSEALED**

# Cavities	Conn. Asm.	Color	Material
2	15326870	Black	PA6 10% GF & 20% GB
3	15326877	Black	PA6 10% GF & 20% GB
4	15326886	Black	PA6 10% GF & 20% GB
5	15326893	Black	PA6 10% GF & 20% GB
6	15326900	Black	PA6 10% GF & 20% GB
8	15326924	Black	PA6 10% GF & 20% GB
10	15326931	Black	PA6 10% GF & 20% GB
12	15326110	Black	PA6 10% GF & 20% GB
16	15326952	Black	PA6 10% GF & 20% GB

Side Lock Covers (SLC) are included in the Connector Assemblies listed in this section.



## Unsealed System Application Information

**CABLE RANGE (mm<sup>2</sup>):** ..... 0.35-5.0  
**CURRENT RANGE (AMPS):** ..... 0-25  
**TEMP RANGE °C:** ..... -40 to 125  
**RESISTANCE:** ..... <10mΩ@20mV  
**VOLTAGE DROP:** ..... <4.0mV/amp  
**CENTERLINE SPACING (mm):** ..... 5.5  
**BLADE WIDTH (mm):** ..... 2.8

### 280 SERIES TERMINALS - Tin Plated

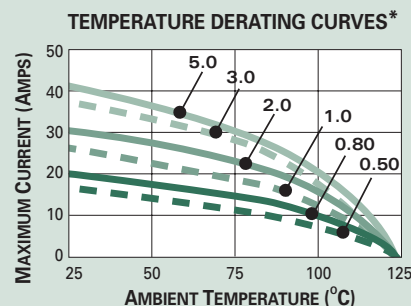
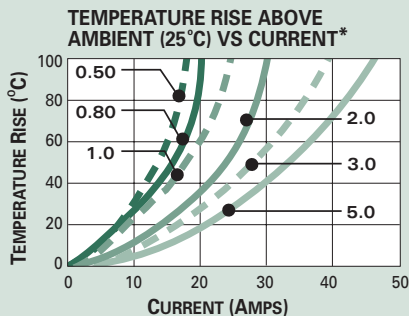

\*The test data are based on single circuits in free space and were generated using a "Lumped Resistance" model. This model does not account for all of the variables that would be present in an actual application. For actual product performance, contact your regional support representative at the number listed below.



#### GT 280 MALE CONNECTOR ASSEMBLIES UNSEALED

# Cavities	Connector	Color	Material
2	15326874	Black	PA6 10% GF & 20% GB
3	15326881	Black	PA6 10% GF & 20% GB
4	15326890	Black	PA6 10% GF & 20% GB
5	15326897	Black	PA6 10% GF & 20% GB
6	15326904	Black	PA6 10% GF & 20% GB
8	15326928	Black	PA6 10% GF & 20% GB
10	15326935	Black	PA6 10% GF & 20% GB
12	15326942	Black	PA6 10% GF & 20% GB
16	15326956	Black	PA6 10% GF & 20% GB

Side Lock Covers (SLC) are included in the Connector Assemblies listed in this section.

#### GT 280 MALE TERMINALS UNSEALED

Part #	Cable Range (mm <sup>2</sup> )	Material	Plating
15304722	0.50-0.35	Tin Brass	Tin
15304723	1.00-0.75	Tin Brass	Tin
15304724	3.00-1.50	Tin Brass	Tin
15304725	5.00-4.00	Tin Brass	Tin

#### SECTION NOTES:

- Contact your regional support representative at the number listed below.
- Due to rigid tolerances of connector cavities, it is critical to meet all crimp dimensions as specified.
- Special consideration must be used when applying terminals 15304713 and 15304725 due to cavity space limitations.

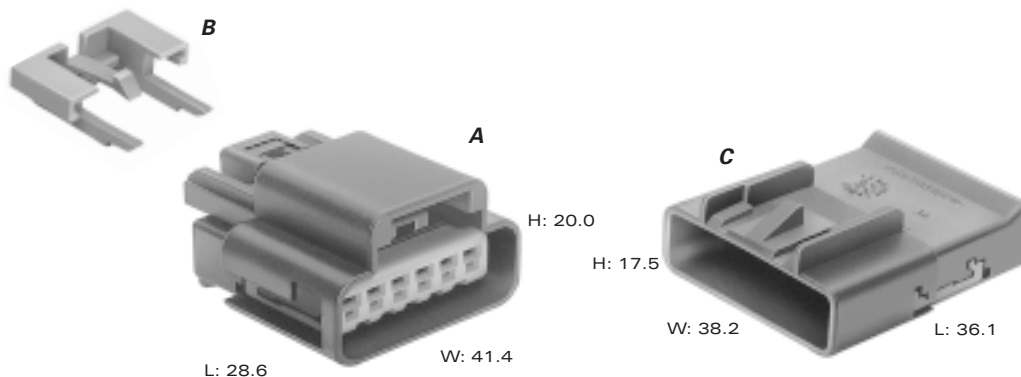

Total Mated Length: 48.7mm

**A PART NO: 15326870**  
 DESCRIPTION: Connector Assembly 2F  
 SIZE: 28.6L x 20.0H x 19.4W  
 COLOR: Black  
 MATERIAL: PA6 10% GF & 20% GB  
 TERMINALS: See Page 22

**C PART NO: 15326874**  
 DESCRIPTION: Connector Assembly 2M  
 SIZE: 36.1L x 17.5H x 16.2W  
 COLOR: Black  
 MATERIAL: PA6 10% GF & 20% GB  
 TERMINALS: See Page 23

**PART NO: 15326877**  
 DESCRIPTION: Connector Assembly 3F  
 SIZE: 28.6L x 20.0H x 24.9W  
 COLOR: Black  
 MATERIAL: PA6 10% GF & 20% GB  
 TERMINALS: See Page 22

**PART NO: 15326881**  
 DESCRIPTION: Connector Assembly 3M  
 SIZE: 36.1L x 17.5H x 21.7W  
 COLOR: Black  
 MATERIAL: PA6 10% GF & 20% GB  
 TERMINALS: See Page 23

**PART NO: 15326886**  
 DESCRIPTION: Connector Assembly 4F  
 SIZE: 28.6L x 20.0H x 30.4W  
 COLOR: Black  
 MATERIAL: PA6 10% GF & 20% GB  
 TERMINALS: See Page 22

**PART NO: 15326890**  
 DESCRIPTION: Connector Assembly 4M  
 SIZE: 36.1L x 17.5H x 27.2W  
 COLOR: Black  
 MATERIAL: PA6 10% GF & 20% GB  
 TERMINALS: See Page 23

**PART NO: 15326893†**  
 DESCRIPTION: Connector Assembly 5F  
 SIZE: 28.6L x 20.0H x 35.9W  
 COLOR: Black  
 MATERIAL: PA6 10% GF & 20% GB  
 TERMINALS: See Page 22

**PART NO: 15326897**  
 DESCRIPTION: Connector Assembly 5M  
 SIZE: 36.1L x 17.5H x 32.7W  
 COLOR: Black  
 MATERIAL: PA6 10% GF & 20% GB  
 TERMINALS: See Page 23

**PART NO: 15326900**  
 DESCRIPTION: Connector Assembly 6F  
 SIZE: 28.6L x 20.0H x 41.4W  
 COLOR: Black  
 MATERIAL: PA6 10% GF & 20% GB  
 TERMINALS: See Page 22

**PART NO: 15326904**  
 DESCRIPTION: Connector Assembly 6M  
 SIZE: 36.1L x 17.5H x 38.2W  
 COLOR: Black  
 MATERIAL: PA6 10% GF & 20% GB  
 TERMINALS: See Page 23

**B PART NO: 15317832**  
 DESCRIPTION: CPA  
 COLOR: Gray  
 MATERIAL: PA6 10% GF & 20% GB

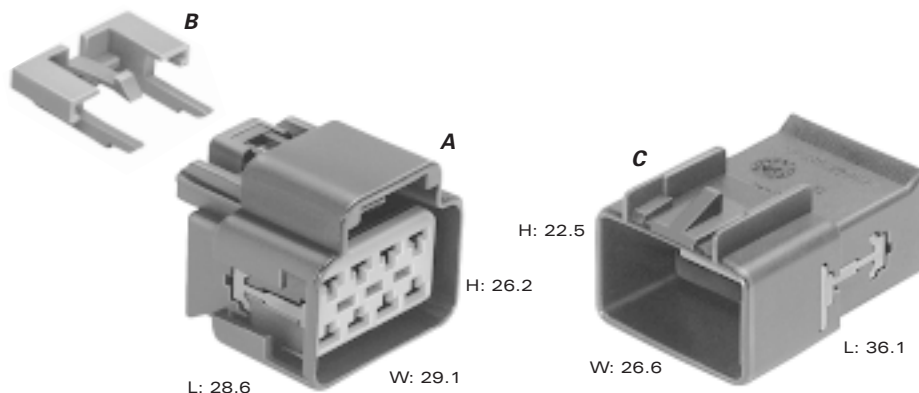

Total Mated Length: 48.7mm

**A PART NO: 15326924**  
 DESCRIPTION: Connector Assembly 8F  
 SIZE: 28.6L x 26.2H x 29.1W  
 COLOR: Black  
 MATERIAL: PA6 10% GF & 20% GB  
 TERMINALS: See Page 22

**PART NO: 15326931**  
 DESCRIPTION: Connector Assembly 10F  
 SIZE: 28.6L x 26.2H x 34.6W  
 COLOR: Black  
 MATERIAL: PA6 10% GF & 20% GB  
 TERMINALS: See Page 22

**PART NO: 15326110**  
 DESCRIPTION: Connector Assembly 12F  
 SIZE: 28.6L x 26.2H x 40.1W  
 COLOR: Black  
 MATERIAL: PA6 10% GF & 20% GB  
 TERMINALS: See Page 22

**PART NO: 15326952**  
 DESCRIPTION: Connector Assembly 16F  
 SIZE: 28.6L x 26.2H x 51.1W  
 COLOR: Black  
 MATERIAL: PA6 10% GF & 20% GB  
 TERMINALS: See Page 22

**B PART NO: 15317832**  
 DESCRIPTION: CPA  
 COLOR: Gray  
 MATERIAL: PA6 10% GF & 20% GB

**C PART NO: 15326928**  
 DESCRIPTION: Connector Assembly 8M  
 SIZE: 36.1L x 22.5H x 26.6W  
 COLOR: Black  
 MATERIAL: PA6 10% GF & 20% GB  
 TERMINALS: See Page 23

**PART NO: 15326935**  
 DESCRIPTION: Connector Assembly 10M  
 SIZE: 36.1L x 22.5H x 32.1W  
 COLOR: Black  
 MATERIAL: PA6 10% GF & 20% GB  
 TERMINALS: See Page 23

**PART NO: 15326942**  
 DESCRIPTION: Connector Assembly 12M  
 SIZE: 36.1L x 22.5H x 37.6W  
 COLOR: Black  
 MATERIAL: PA6 10% GF & 20% GB  
 TERMINALS: See Page 23

**PART NO: 15326956**  
 DESCRIPTION: Connector Assembly 16M  
 SIZE: 36.1L x 22.5H x 48.6W  
 COLOR: Black  
 MATERIAL: PA6 10% GF & 20% GB  
 TERMINALS: See Page 23



**Cross Sectional View**

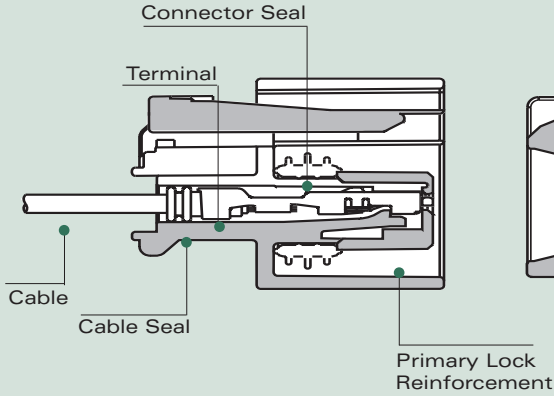

**Female Connector Assembly**

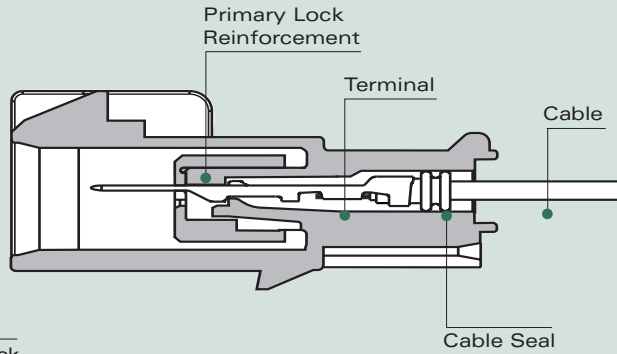

**Male Connector Assembly**



Connector Position Assurance (CPA)

Cable Seal

Female Terminal



Connector Seal

Primary Lock Reinforcement (PLR)

Female Connector Assembly

**GT 280 FEMALE TERMINALS SEALED**

Part #	Cable Range (mm <sup>2</sup> )	Material	Plating
15304718	0.50-0.35	Tin Brass	Tin
15304719	1.00-0.75	Tin Brass	Tin
15304720	3.00-1.50	Tin Brass	Tin
15326004	5.00-4.00	Beryllium Copper	Tin



**GT 280 CABLE SEALS**

Reel Part #	Loose Part #	Cable Diameter	Material	Color
12191221	15366065	1.20-1.85	Silicone	Orange
12191222	15366066	1.86-2.25	Silicone	Yellow
12191223	15366067	2.50-3.20	Silicone	Tan
-	12191235	3.40-3.90	Silicone	Purple

**GT 280 FEMALE CONNECTOR ASSEMBLIES SEALED**

# Cavities	Conn. Asm.	Color	Material
2	15326679	Black	PA6 10% GF & 20% GB
3	15326614	Black	PA6 10% GF & 20% GB
4	15326631	Black	PA6 10% GF & 20% GB
5	15326642	Black	PA6 10% GF & 20% GB
6	15326635	Black	PA6 10% GF & 20% GB
8	15326654	Black	PA6 10% GF & 20% GB
10	15326660	Black	PA6 10% GF & 20% GB
12	15326910	Black	PA6 10% GF & 20% GB
14	15326917	Black	PA6 10% GF & 20% GB
16	15326666	Black	PA6 10% GF & 20% GB

Primary Lock Reinforcement (PLR) and Connector Seals are included in the Connector Assemblies listed in this section.

<http://delphi.com/products/connect>



## Sealed System Application Information

**CABLE RANGE (mm<sup>2</sup>):** ..... 0.35-5.0  
**CURRENT RANGE (AMPS):** ..... 0-25  
**TEMP RANGE °C:** ..... -40 to 125  
**RESISTANCE:** ..... <10mΩ@20mV  
**VOLTAGE DROP:** ..... <4.0mV/amp  
**CENTERLINE SPACING (mm):** ..... 6.5  
**BLADE WIDTH (mm):** ..... 2.8

### 280 SERIES TERMINALS - Tin Plated

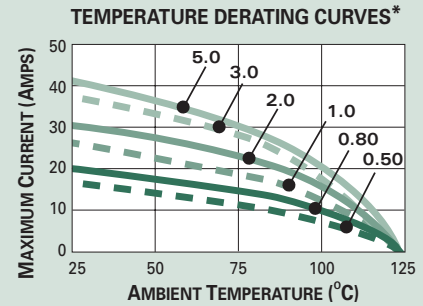
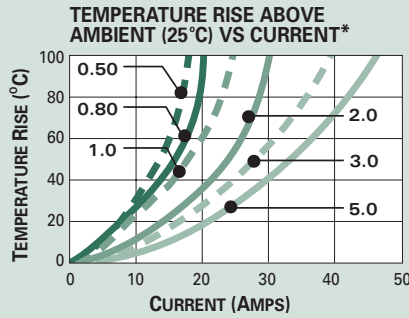

\*The test data are based on single circuits in free space and were generated using a "Lumped Resistance" model. This model does not account for all of the variables that would be present in an actual application. For actual product performance, contact your regional support representative at the listed below.

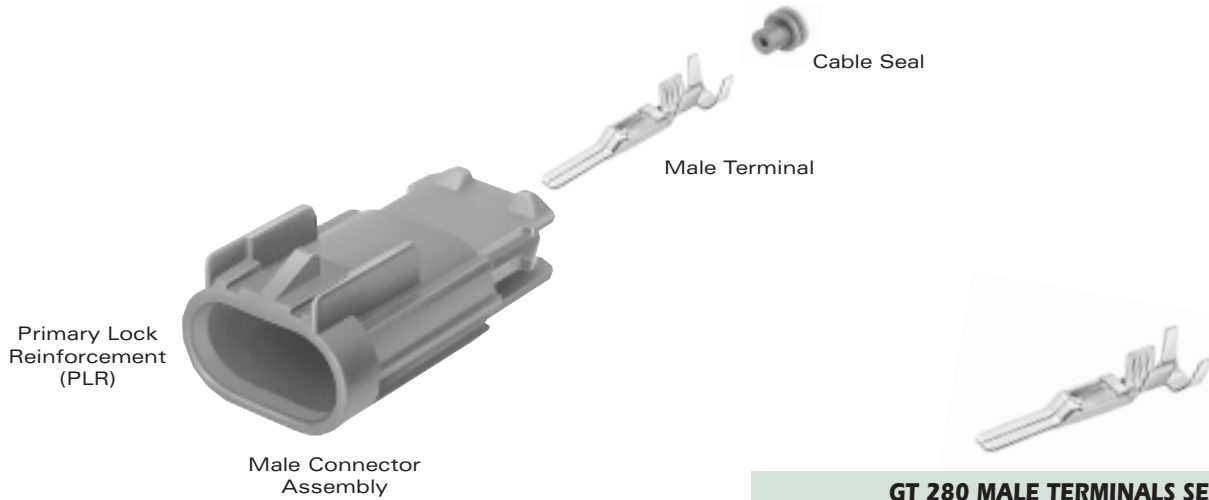

GT 280 MALE CONNECTOR ASSEMBLIES SEALED			
# Cavities	Connector	Color	Material
2	15326678	Black	PA6 10% GF & 20% GB
3	15326623	Black	PA6 10% GF & 20% GB
4	15326633	Black	PA6 10% GF & 20% GB
5	15326647	Black	PA6 10% GF & 20% GB
6	15326640	Black	PA6 10% GF & 20% GB
8	15326655	Black	PA6 10% GF & 20% GB
10	15326661	Black	PA6 10% GF & 20% GB
12	15326915	Black	PA6 10% GF & 20% GB
14	15326922	Black	PA6 10% GF & 20% GB
16	15326667	Black	PA6 10% GF & 20% GB

Primary Lock Reinforcement is included in the Connector Assemblies listed in this section.

GT 280 MALE TERMINALS SEALED			
Part #	Cable Range (mm <sup>2</sup> )	Material	Plating
15304730	0.50-0.35	Tin Brass	Tin
15304731	1.00-0.75	Tin Brass	Tin
15304732	3.00-1.50	Tin Brass	Tin

GT 280 CAVITY PLUG*			
Part #	Cavity Diameter	Material	Color
15305170	5.8mm	Silicone	White

\*Cavity plugs seal unused female and male cavities.

#### SECTION NOTES:

- Contact your regional support representative at the number listed below.
- Due to rigid tolerances of connector cavities, it is critical to meet all crimp dimensions as specified.

<http://delphi.com/products/connect>

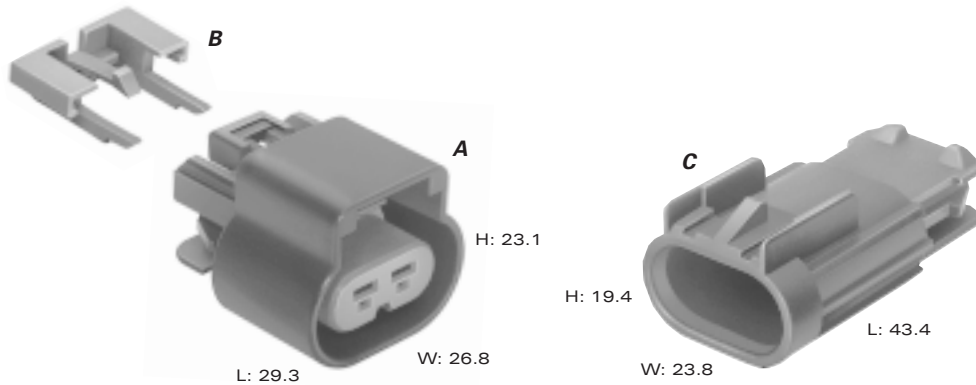

Total Mated Length: 56.7mm

**A PART NO: 15326679**  
 DESCRIPTION: Connector Assembly 2F  
 SIZE: 29.3L x 23.1H x 26.8W  
 COLOR: Black  
 MATERIAL: PA6 10% GF & 20% GB  
 TERMINALS: See Page 26  
 SEALS/PLUGS: See Page 26, 27

**C PART NO: 15326678**  
 DESCRIPTION: Connector Assembly 2M  
 SIZE: 43.4L x 19.4H x 23.8W  
 COLOR: Black  
 MATERIAL: PA6 10% GF & 20% GB  
 TERMINALS: See Page 27  
 SEALS/PLUGS: See Page 26, 27

**PART NO: 15326614**  
 DESCRIPTION: Connector Assembly 3F  
 SIZE: 29.3L x 23.1H x 33.3W  
 COLOR: Black  
 MATERIAL: PA6 10% GF & 20% GB  
 TERMINALS: See Page 26  
 SEALS/PLUGS: See Page 26, 27

**PART NO: 15326623**  
 DESCRIPTION: Connector Assembly 3M  
 SIZE: 43.4L x 19.4H x 30.3W  
 COLOR: Black  
 MATERIAL: PA6 10% GF & 20% GB  
 TERMINALS: See Page 27  
 SEALS/PLUGS: See Page 26, 27

**PART NO: 15326631**  
 DESCRIPTION: Connector Assembly 4F  
 SIZE: 29.3L x 23.1H x 39.8W  
 COLOR: Black  
 MATERIAL: PA6 10% GF & 20% GB  
 TERMINALS: See Page 26  
 SEALS/PLUGS: See Page 26, 27

**PART NO: 15326633**  
 DESCRIPTION: Connector Assembly 4M  
 SIZE: 43.4L x 19.4H x 36.8W  
 COLOR: Black  
 MATERIAL: PA6 10% GF & 20% GB  
 TERMINALS: See Page 27  
 SEALS/PLUGS: See Page 26, 27

**PART NO: 15326642**  
 DESCRIPTION: Connector Assembly 5F  
 SIZE: 29.3L x 23.1H x 46.3W  
 COLOR: Black  
 MATERIAL: PA6 10% GF & 20% GB  
 TERMINALS: See Page 26  
 SEALS/PLUGS: See Page 26, 27

**PART NO: 15326647**  
 DESCRIPTION: Connector Assembly 5M  
 SIZE: 43.4L x 19.4H x 43.3W  
 COLOR: Black  
 MATERIAL: PA6 10% GF & 20% GB  
 TERMINALS: See Page 27  
 SEALS/PLUGS: See Page 26, 27

**PART NO: 15326635**  
 DESCRIPTION: Connector Assembly 6F  
 SIZE: 29.3L x 23.1H x 52.8W  
 COLOR: Black  
 MATERIAL: PA6 10% GF & 20% GB  
 TERMINALS: See Page 26  
 SEALS/PLUGS: See Page 26, 27

**PART NO: 15326640**  
 DESCRIPTION: Connector Assembly 6M  
 SIZE: 43.4L x 19.4H x 49.8W  
 COLOR: Black  
 MATERIAL: PA6 10% GF & 20% GB  
 TERMINALS: See Page 27  
 SEALS/PLUGS: See Page 26, 27

**B PART NO: 15317832**  
 DESCRIPTION: CPA  
 COLOR: Gray  
 MATERIAL: PA6 10% GF & 20% GB

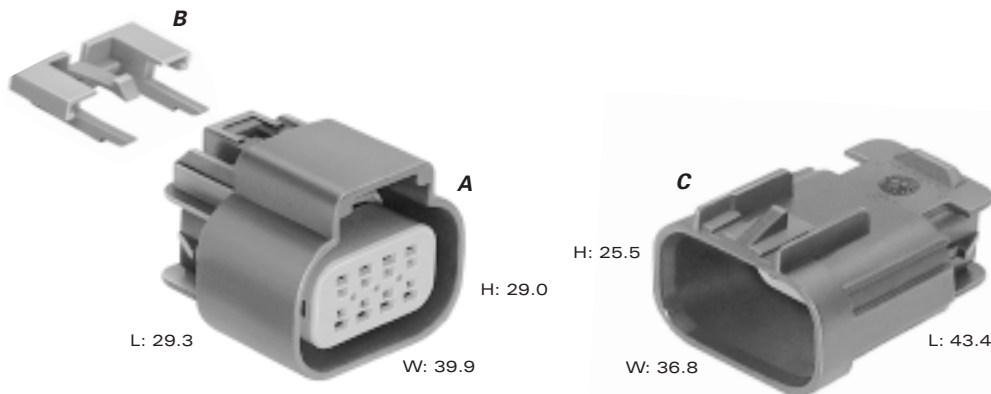

Total Mated Length: 56.7mm

**A PART NO: 15326654**  
 DESCRIPTION: Connector Assembly 8F  
 SIZE: 29.3L x 29.0H x 39.9W  
 COLOR: Black  
 MATERIAL: PA6 10% GF & 20% GB  
 TERMINALS: See Page 26  
 SEALS/PLUGS: See Page 26, 27

**PART NO: 15326660**  
 DESCRIPTION: Connector Assembly 10F  
 SIZE: 29.3L x 29.0H x 46.4W  
 COLOR: Black  
 MATERIAL: PA6 10% GF & 20% GB  
 TERMINALS: See Page 26  
 SEALS/PLUGS: See Page 26, 27

**PART NO: 15326910**  
 DESCRIPTION: Connector Assembly 12F  
 SIZE: 29.3L x 29.0H x 52.9W  
 COLOR: Black  
 MATERIAL: PA6 10% GF & 20% GB  
 TERMINALS: See Page 26  
 SEALS/PLUGS: See Page 26, 27

**PART NO: 15326917**  
 DESCRIPTION: Connector Assembly 14F  
 SIZE: 29.3L x 29.0H x 59.4W  
 COLOR: Black  
 MATERIAL: PA6 10% GF & 20% GB  
 TERMINALS: See Page 26  
 SEALS/PLUGS: See Page 26, 27

**PART NO: 15326666**  
 DESCRIPTION: Connector Assembly 16F  
 SIZE: 29.3L x 29.0H x 65.9W  
 COLOR: Black  
 MATERIAL: PA6 10% GF & 20% GB  
 TERMINALS: See Page 26  
 SEALS/PLUGS: See Page 26, 27

**B PART NO: 15317832**  
 DESCRIPTION: CPA  
 COLOR: Gray  
 MATERIAL: PA6 10% GF & 20% GB

**C PART NO: 15326655**  
 DESCRIPTION: Connector Assembly 8M  
 SIZE: 43.4L x 25.5H x 36.8W  
 COLOR: Black  
 MATERIAL: PA6 10% GF & 20% GB  
 TERMINALS: See Page 27  
 SEALS/PLUGS: See Page 26, 27

**PART NO: 15326661**  
 DESCRIPTION: Connector Assembly 10M  
 SIZE: 43.4L x 25.5H x 43.3W  
 COLOR: Black  
 MATERIAL: PA6 10% GF & 20% GB  
 TERMINALS: See Page 27  
 SEALS/PLUGS: See Page 26, 27

**PART NO: 15326915**  
 DESCRIPTION: Connector Assembly 12M  
 SIZE: 43.4L x 25.5H x 49.8W  
 COLOR: Black  
 MATERIAL: PA6 10% GF & 20% GB  
 TERMINALS: See Page 27  
 SEALS/PLUGS: See Page 26, 27

**PART NO: 15326922**  
 DESCRIPTION: Connector Assembly 14M  
 SIZE: 43.4L x 25.5H x 56.3W  
 COLOR: Black  
 MATERIAL: PA6 10% GF & 20% GB  
 TERMINALS: See Page 27  
 SEALS/PLUGS: See Page 26, 27

**PART NO: 15326667**  
 DESCRIPTION: Connector Assembly 16M  
 SIZE: 43.4L x 25.5H x 62.8W  
 COLOR: Black  
 MATERIAL: PA6 10% GF & 20% GB  
 TERMINALS: See Page 27  
 SEALS/PLUGS: See Page 26, 27





GT 280 Connection Systems are designed to mate to most headlamps, including a variety of daytime running lamps, high beam, and dual filament BULBS.

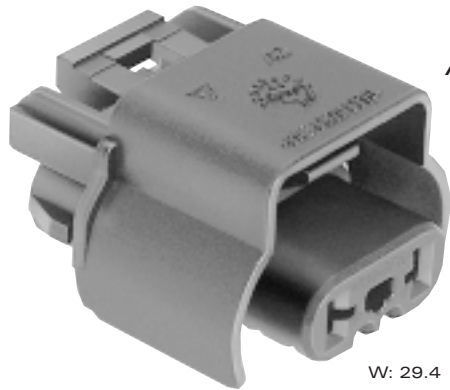

**A**

H: 23.8

W: 29.4

L: 35.8

- A PART NO: 15336116**
- DESCRIPTION: Connector Assembly 2F
- SIZE: 35.8L x 23.8H x 29.4W
- COLOR: Black
- MATERIAL: PA6 20% GF & 10% GB
- TERMINALS: See Page 26
- SEALS/PLUGS: See Page 84, 85



**B**

H: 23.8

W: 29.4

L: 35.8

- B PART NO: 15336117**
- DESCRIPTION: Connector Assembly 2F
- SIZE: 35.8L x 23.8H x 29.4W
- COLOR: Brown
- MATERIAL: PA6 20% GF & 10% GB
- TERMINALS: See Page 26
- SEALS/PLUGS: See Page 84, 85